

Glasroc® X

Gypsum board for exterior applications



DON'T IMAGINE, YOU HAVE IT.





GLASROC® X, THE BOARD WITH HIGH RESISTANCE TO MOISTURE AND MOULD, FOR EXTERIOR APPLICATIONS

Glasroc® X

Glasroc® X is a high performance board with a gypsum core containing special additives for moisture and mould resistance. Glasroc® X is reinforced board with a glass-mat on both surfaces and finished with a UV resistant coating, providing outstanding performance in humid environments.

This non-paper faced board, free from cellulose content and therefore has a strong inherent resistance to mould growth, which is perfect for wet areas and high-humidity environments including exterior applications.

Glass-mats have a physical anchorage in with the gypsum core ensuring a strong bond with the gypsum core that creates a monolithic board of high strength, solidity and exceptional integrity.

Glasroc® X is an ideal substrate for ETICS (External Thermal Insulation Systems) or Direct Render application (also known as Direct Apply Systems). This high performance board can be used for areas requiring high protection against water and it has been designed especially for exterior applications. This board is a perfect solution for exterior ceilings, external walls systems and façade cladding systems.

Glasroc® X is available 1200mm wide in either 2400 or 3000mm length (other lengths can be available to order depending on quantities required) with longitudinal tapered or squared edges depending on the finishing system.

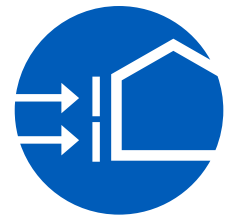

Inorganic glass mat surface with strong visual branding for instant product identification and provides a surface that has high resistance to mould and water penetration



Glass fiber reinforced gypsum core, moisture and mould resistance and very low water absorption.

BOARD PROPERTIES

SPECIFICATIONS		Value	Unit
Board classification (EN 15283-1)		GM-H1	
Thickness		12,5	mm
Width		1200	mm
Standard length		2400, 3000	mm
Weight		10,9	kg/m ²
Total water absorption (EN 520)		≤ 5 (H1)	%
Surface water absorption (EN 520)		< 45	g/m ²
Mould resistant (ASTM D3273)		10 (No mould)	-
UV resistant		12	months
Dimensional stability	Thermal expansion (EN 14581)	$0,8 \times 10^{-5}$	°C ⁻¹
	Moisture expansion (EN 12467)	0,005	mm/m-1%RH (30-90 %RH)
Flexural strength	Longitudinal	≥ 540	N
	Transversal	≥ 210	N
Minimum bending radius		1,5	m
Thermal conductivity λ		0,1865	W/mK
Vapour diffusion μ		18,2	-
Fire reaction (EN 13501-1)		A1	-

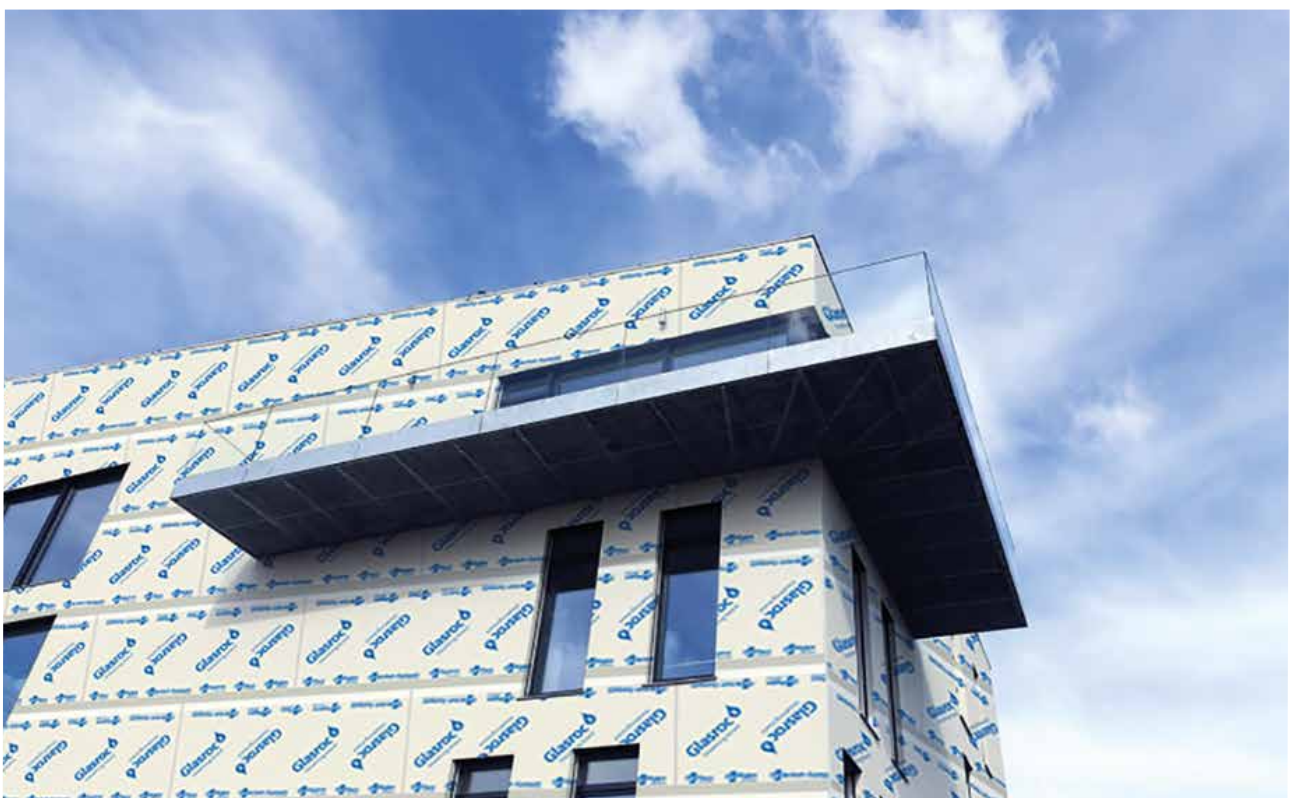

PRODUCT FEATURES



Exterior Application



Moisture and Mould Resistance



Fire Resistance



Dimensional Stability



Energy Efficiency



Low Environmental Impact



Impact Resistance



Flexibility



Easy to Score and Snap



Easy to screw fix



Easy to Handle



High Labour Productivity



Tapered Edge

Square Edge

APPLICATIONS



EXTERNAL CEILINGS

Semi-exposed ceiling areas above balconies



BALCONIES

Wall linings for balconies and terraces



FAÇADE

Wall linings for ventilated or non-ventilated façades



Glasroc® X has been tested with ETAG verification procedures drawn up by EOTA (European Organisation for Technical Assessment) and harmonised UNE standards for façade and exterior cladding and sheathing applications, while covering the requirements of the EN 15283-1 standard for CE marking, as summarised in the relevant declaration of performance.

 WATER	 WEATHER BEHAVIOR	 HYGROTHERMAL	 FIRE	 EXTERNAL IMPACTS
Surface absorption <math><45\text{g}/\text{m}^2</math> Total absorption <math><5\%</math>	Watertightness: 1400 Pa Airtightness: Class A4	Hygrothermal behavior -20°C to +70°C	Reaction to fire A1	ETAG 034 Façades Category I



EAVES
 Linings for eaves and soffits



FASCIAS
 Façade fronts



ARCHES
 Linings to curved surfaces such as arches and columns with minimum bending radius 1,5 m

SURFACE FINISHES

Unfinished board



The board can be left without finishing for inner façade wall solutions, where the board is exposed to a protected cavity or air cavity. A joint treatment should be applied using adhesive tape or PU or modified silicone mastic for out door application.

Direct Render system



Direct Render finishing is used for the construction of external walls in which the board is exposed to the external environment. The render should be a compatible basecoat mortar. It must be used a reinforcement mesh and finish the system using an acrylic or siloxane-based topcoat.

ETICS / EIFS System



ETICS or EIFS System is used for construction of external walls in which the board is exposed to the outside, when the choice is a system with External Thermal Insulation Composite Systems (ETICS), in which the insulation panels may be given a cement-free adhesive on the board and then mechanically fixed to the metal studs.

SOLUTIONS

1. EXTERNAL WALL SYSTEMS

External wall with Direct Render System



1. Internal board (s)
2. Metal framing
3. Insulation
4. Glasroc® X
5. Adhesive
6. Insulating panel
7. Basecoat
8. Mesh
9. Topcoat

External wall with ETICS System

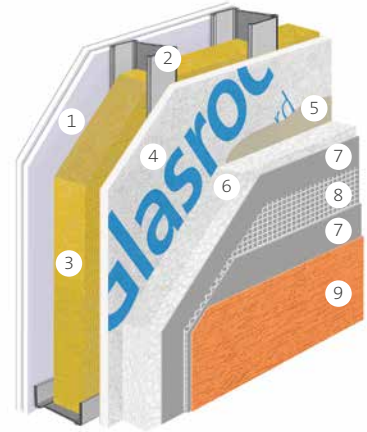

Used as an external board for direct rendering on single façade walls.

Used as a finished external board with ETICS on single façade walls.

Double External wall with Direct Render System

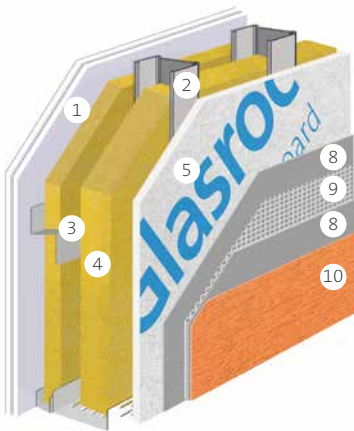

1. Internal board (s)
2. External Metal framing
3. Internal Metal framing
4. Insulation
5. Glasroc® X
6. Adhesive
7. Insulating panel
8. Basecoat
9. Mesh
10. Topcoat

Double External wall with ETICS System

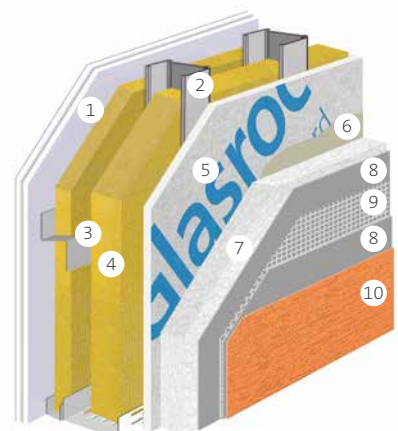

Used as an external board for direct rendering on double façade walls.

Used as a finished external board with ETICS on double façade walls.

SOLUTIONS

2. CLADDING SYSTEMS

External cladding system with aluminium frame

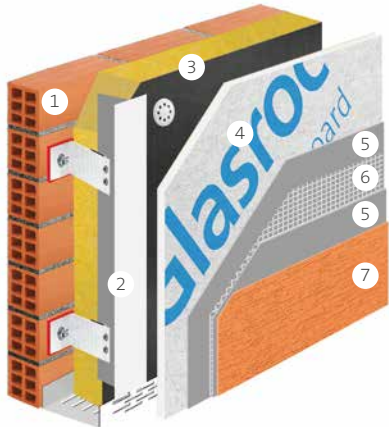

1. Solid wall
2. Metal framing
3. Insulation
4. Glasroc® X
5. Basecoat
6. Mesh
7. Topcoat

Used in the renovation of buildings including a new external cladding system with a ventilated or non-ventilated cavity held in place using a frame system with aluminium profiles.

External cladding system with galvanized frame

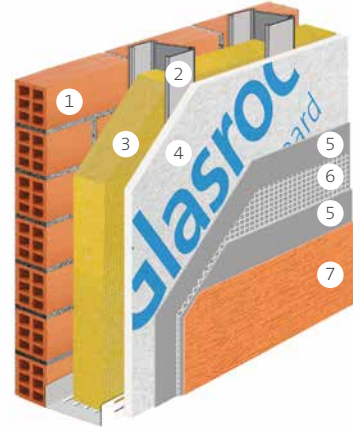

Used in the renovation of buildings including a new external cladding system with a ventilated or non-ventilated cavity held in place using a galvanized profiles frame.

Cavity System

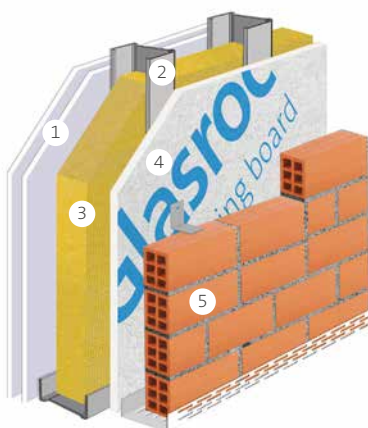

1. Internal board (s)
2. Metal framing
3. Insulation
4. Glasroc® X
5. External cladding finishing

Used in dry constructed external walls of new buildings to maintain traditional finishing. As the final layer to an inner leaf exposed to an air cavity and providing a barrier that has resistance to humidity using joint sealants.

Siding System



Used in traditional aesthetic systems. As the final layer to an inner leaf protected by an external paneling system, indirect board surface or ventilated facade providing a barrier that has resistance to humidity using joint sealants.

3. EXTERNAL WALL + CLADDING SYSTEM

External wall with Cladding system (Aquaroc®)

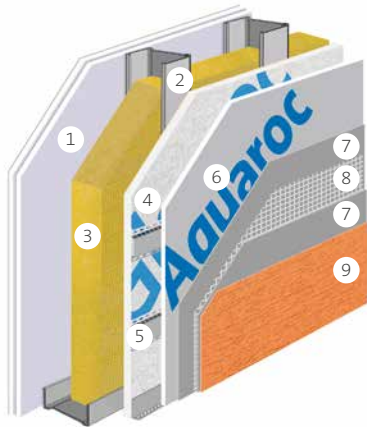

1. Internal board(s)
2. Internal metal framing
3. Insulation
4. Glasroc® X
5. Cladding metal frame
6. Aquaroc
7. Basecoat
8. Mesh
9. Topcoat

Double external wall with Cladding system (Aquaroc®)

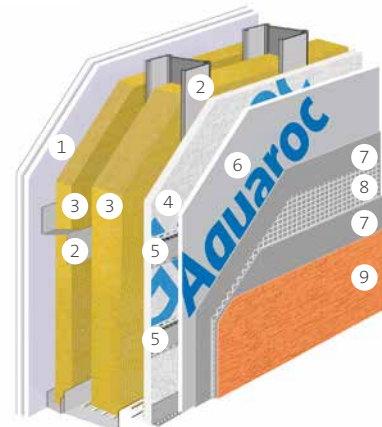

As the final layer of an internal leaf protected from the outside using an Aquaroc® facade with a ventilated cavity and providing a humidity resistant barrier. Joint sealants prevent air and moisture entering the cavity also no waterproofing membrane is required unless stipulated by local Regulations or necessary to suit climate conditions.

External wall with Cladding system (Glasroc® X)

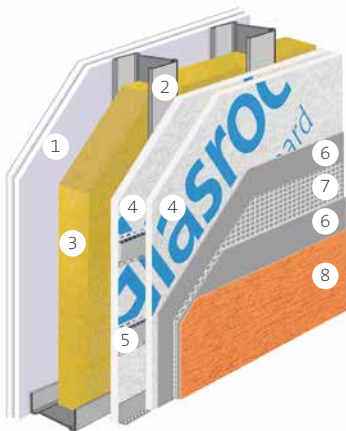

1. Internal board(s)
2. Internal metal framing
3. Insulation
4. Glasroc® X
5. Cladding frame
6. Basecoat
7. Mesh
8. Topcoat

Double external wall with Cladding system (Glasroc® X)

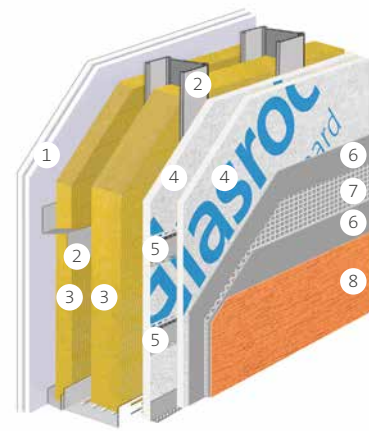

As the final layer of an internal leaf protected from the outside using an Glasroc® X facade with a ventilated cavity and providing a humidity resistant barrier. Joint sealants prevent air and moisture entering the cavity also no waterproofing membrane is required unless stipulated by local Regulations or necessary to suit climate conditions.



DESIGNED FOR VENTILATED AND
NON-VENTILATED FAÇADE
COMPATIBLE WITH DIRECT RENDER
AND EIFS SYSTEMS

INSTALLATION GUIDE

1. INSTALLATION OF GLASROC® X BOARDS

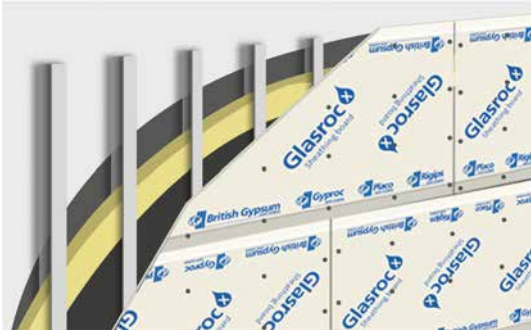

01 Boards

For all exterior applications, boards should be installed horizontally starting at least 20 cm from the bottom, or waterproofed first 20 cm, to avoid direct contact with the ground (for interior application, 2 cm from the floor and 1 cm from ceiling) and a joint gap around 3 mm between boards. Boards should be fixed to metal profiles with a galvanized coating not less than Z275 or to aluminum profiles. The thickness and spacing of these profiles are calculated in accordance with local regulations to support the self-weight of boards and wind factors, with spacings from 400 - 600 mm centres. The gap between the vertical joints of two rows of adjacent boards should be no less than 800mm.

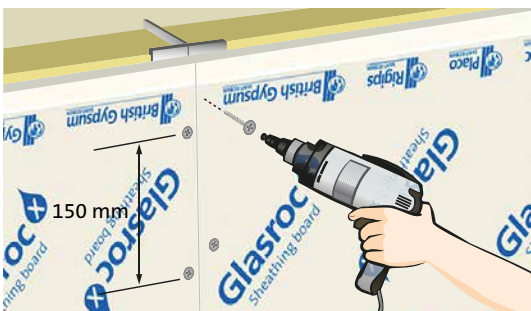

02 Board fixing

Boards should be fixed using self-tapping screws appropriate for the board type and thickness of the metal profiles at no greater than 150 mm centres - no less than 10 mm from the board edges. It is recommended to use a stagger pattern of at least 20 mm for the fixings. Screw heads should finish flush with the board surface without damage to the core.

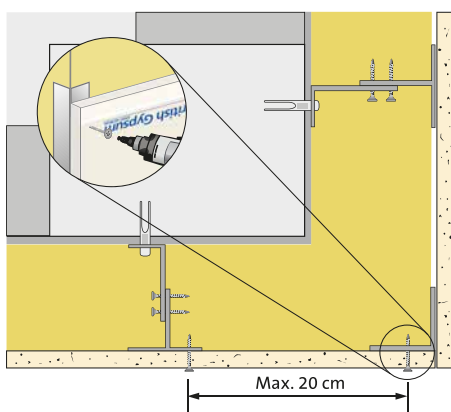

03 Corner reinforcement

For inner and outer corners, the board can overlap the last profile by a maximum of 20 cm. In all cases the edge of the board must be reinforced with an angle profile.

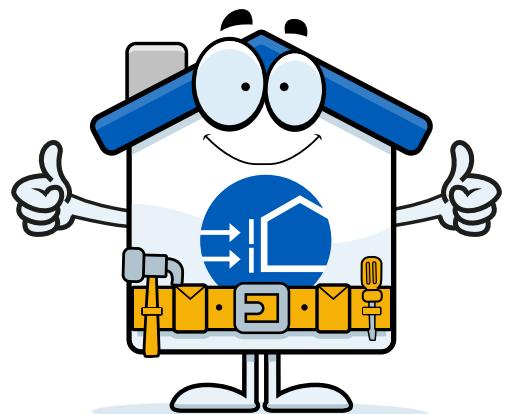
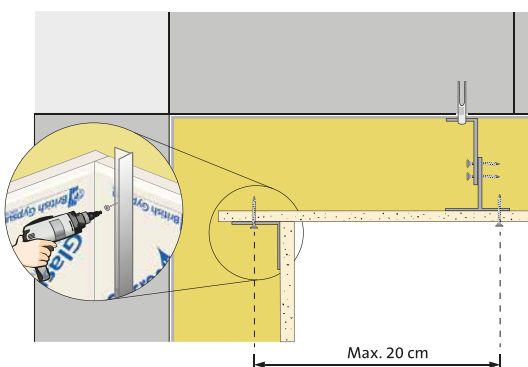

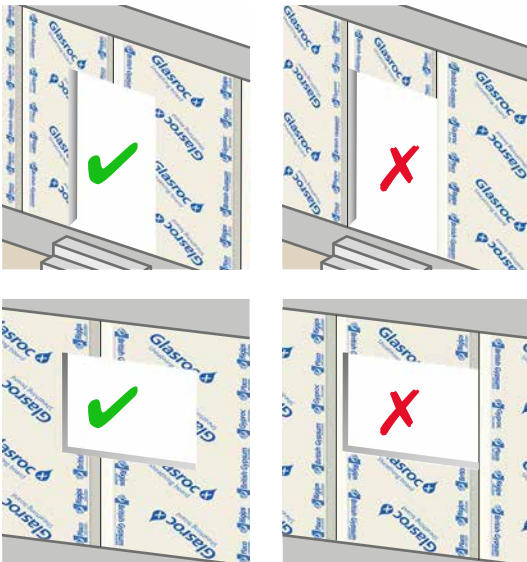

04 Doors and windows areas

For gap formation for windows and doors, joints between boards may not coincide with the plumb line of lintels, window cases or door jambs, as there should be at least 40cm between vertical joints and 15 cm between horizontal joints.

All joinery work must be fixed to independent frames so as not to transfer loads onto the boards.

In sections used for forming window sills, boards should ensure a slope of at least 10° for water drainage.



05 Expansion joints

Glasroc® X's high dimensional stability makes it ideal for large continuous façade areas, which are only interrupted every 15 m maximum for vertical joints, in addition to those required by the building's structural joints or for changes in the size of the façade leaves. Equally possible in these cases are the creation of horizontal joints.

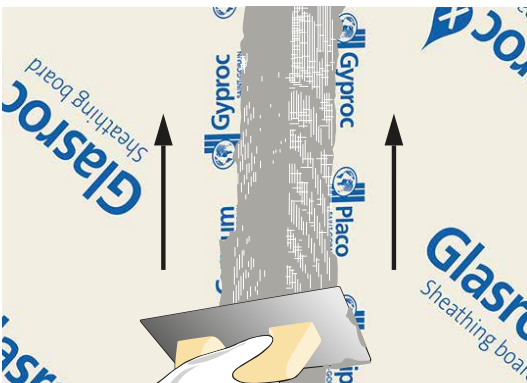

06 Joint treatment

Joint treatment is determined in each case by the type of application of Glasroc® X and surface covering.

When boards are not exposed to the outside (cavity or sidings systems and external walls with cladding systems over), simple sealing with an outdoor mastic or adhesive tape will be sufficient, provided it overlaps joints and connections by at least 10 cm on all sides to ensure continuity of the seal.

Where boards require a direct finish, a band of not less than 15 cm in width should be applied using the render plus 160 reinforcing mesh overlapped at least 15 cm at joints and connections to ensure continuity.

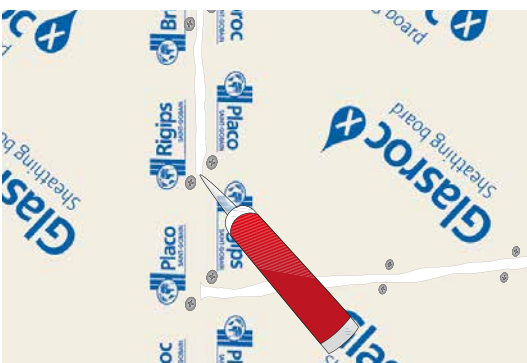

07 Window angles and lintels

To prevent the appearance of cracks at angles forming gaps when the boards will be given a direct render coat, diagonal bands measuring 20 x 40 cm minimum of 160 reinforcing mesh should be placed at 45° before applying the render.

Similarly, the edges of these gaps should be reinforced with ancillary PVC profiles for corners and drip-proofing.

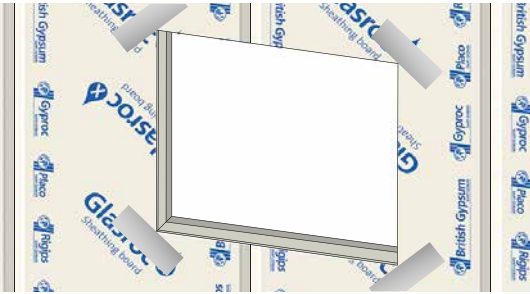

2. SURFACE COVERING SOLUTIONS "DIRECT RENDER" FINISHING



08A Basecoat

The application of compatible render, such as weber.therm Armierungsspachtel must be carried out after joint treatment. A first coat of about 2 mm in thickness is applied over the whole surface.

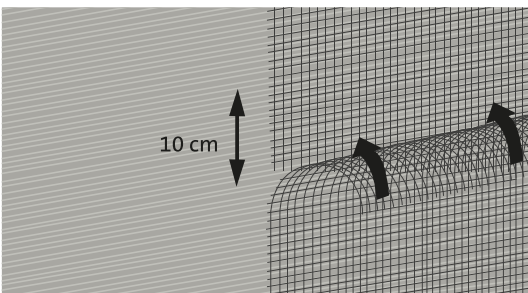

09A Mesh

Over the fresh coat of rendering, 160 mesh should be applied so as to overlap with mesh joints at least 10 cm to ensure continuity. The mesh must be completely covered by the render using the appropriate trowel. Similarly, when other ancillary profiles as required by the façade design are applied, such as corner reinforcements, lintel drip-proofing, vertical and horizontal joints, or clip-type base or top profiles, these must be fully covered by the render.

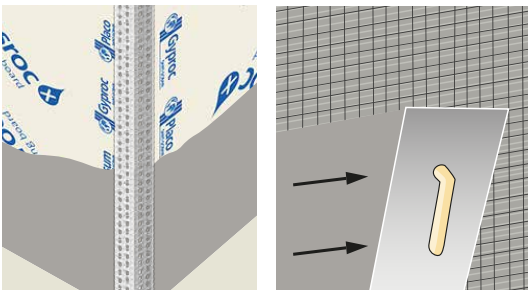

10A Basecoat, second layer

A second coat is then applied to cover the entire surface with a total thickness of 3 to 5 mm, smooth and ready for the application of finishes or topcoats.



11A Topcoat

After the appropriate drying time of the first render coat as recommended by the manufacturer, usually around 48 hrs, a primer such as weber CS Plus should be applied using a roller or brush in opposite directions, which should be in a colour similar to the final finish.

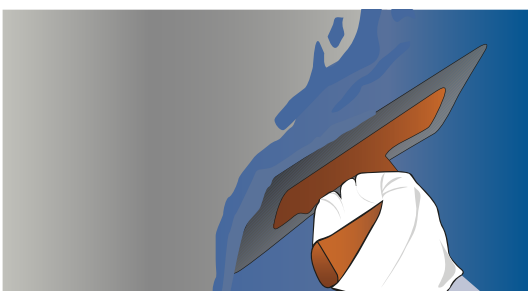

Once the primer is dry, an acrylic or siloxane-base topcoat such as weber.tene Stilo, Geos or Micro may be applied following the recommendations of the manufacturer.

3. SURFACE COVERING SOLUTIONS: ETICS FINISHING

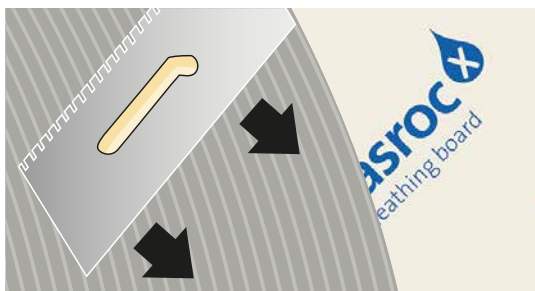

08B Adhesive

A cement-free adhesive such as weber.therm Dispersionskleber should be applied over Glasroc® X boards for the subsequent fixing of insulation panels.

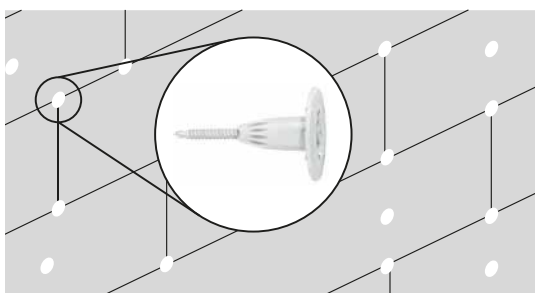

09B Insulation panels

Insulation panels should be fixed using the adhesive as described, avoiding coinciding Glasroc® X board joints behind them. They should be fixed using self-tapping screws to the profiles of the system, perforating the Glasroc® X board system. The number of screws is usually determined by the manufacturer of the ETICS being used (5 or 6 self-tapping-screws per m² is usually enough).



10B Basecoat

The basecoat should be applied over the insulation panels following the recommendations of the manufacturer of the ETICS being used. A first coat of about 2 mm in thickness is applied over the whole surface. Similarly, the edges of these gaps should be reinforced with profiles for corners and drip-proofing.

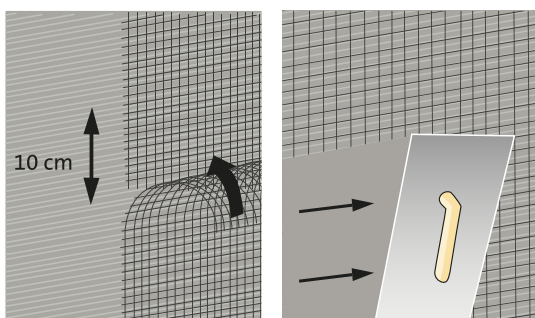

11B Mesh

Over the fresh render coat, 160 reinforcing mesh should be applied so as to overlap with mesh joints at least 10 cm to ensure continuity. The mesh must be completely covered by the product.

12B Basecoat, second layer

A second coat is then applied to cover the entire surface with a total thickness of 3 to 5 mm, smooth and ready for the application of the finishes.

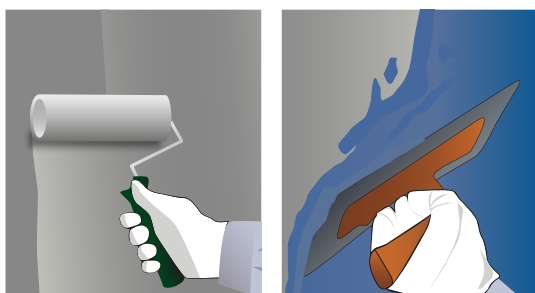

13B Finishes

After the appropriate drying time of the render as recommended by the manufacturer, a finish or topcoat should be applied, and then, after drying, the final finish can be applied as recommended by the manufacturer of the ETICS being used.



BUILDING THE FUTURE OF NEARLY
ZERO ENERGY BUILDINGS



COMPONENTS



Unfinished board



Direct Render system



ETICS / EIFS System



Board

Glasroc® X is a reinforced gypsum board with high impact resistance and UV ray resistance. Specially designed for external applications.



Screws

Screws with corrosion protection for galvanized profiles or stainless steel screws for aluminium profiles.



Joint mastic

Elastic PU mastic or Modified Silicone suitable for outdoors for sealing joints between boards exposed to an air cavity or protected cavity.



Glasroc sealing tape

Adhesive tape 6 cm wide for covering joints between boards exposed to air cavity or protected cavity.



Adhesive (bucket)

Ready-to-use high performance adhesive paste intended for adhesion of EPS panels in ETICS (External Thermal Insulation Composite Systems). Such as weber.therm Dispersionskleber.



Self-tapping screws for ETICS finishes

Self-tapping screws for mechanical fastening of insulation panels for ETICS finishes that can be used to fix them to metal profiles.



Basecoat

Ready-to-use high performance undercoat paste suitable for direct finishes and application and reinforcement of EPS plaques with fibreglass mesh in ETICS (External Thermal Insulation Composite Systems).
Such as weber.therm Armierungspachtel.



160 Mesh

Roll of fibreglass mesh combined with anti-alkali surface treatments for reinforcement of undercoat surfaces over Glasroc X boards and ETICS panels with render.



160 Mesh tape

Fibreglass mesh tape combined with anti-alkali surface treatments for reinforcement of joints over render.



Primer

Base primer and absorption regulator prior to the application of surface coverings from the weber.tene range. Such as weber CS Plus.



Topcoat

Fine-layer acrylic surface covering for weatherproofing, decoration and long-lasting protection of exterior walls and ceilings. Such as weber.tene Stilo, Geos or Micro.

OTHER ACCESSORIES

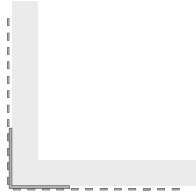

Corner PVC Profile

PVC profile with integrated mesh for reinforcement of inside and outside corners in façade surface coverings with direct finishes or ETICS.

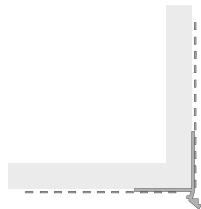

Drip-proof PVC Profile

PVC profile with incorporated mesh providing a drip-proofing edge. Indicated for finishing corners of lintels, façade fronts and lowered ceilings with direct finishes of ETICS.



Expansion joint profile

PVC profile with integrated mesh suitable for vertical board joints for Direct Render or ETICS.



Horizontal Joint PVC Profile with Upper Clip

PVC profile with integrated mesh providing a drip-proofing edge. Suitable for treating top edges on horizontal joints of façade coverings with direct finishes.



Horizontal Joint PVC Profile with Lower Clip

PVC profile with integrated mesh indicated for treatment of lower edges of horizontal joints, and providing a sliding support surface for profiles with Upper Clips on horizontal joints of façade coverings with direct finishes.



Edge Profile

PVC profile for protection of board edges at base or top profiles on surface coverings with direct finishes or ETICS.



Drip-proof PVC Profile with Clip

PVC profile with incorporated mesh providing a drip-proofing edge. Suitable for use with lintels and base edges on façade coverings with direct finishes.

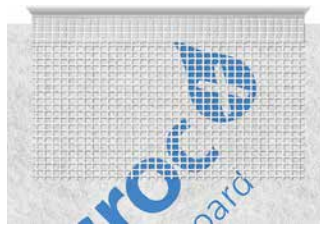

L-Edge PVC Profile with Clip

PVC profile with integrated mesh providing an L-edge for coverings with direct finishes. Indicated for finishing upper edges or façade caps in direct-finish façade systems.



Jamb PVC Profile

PVC profile incorporating a flexible joint for jambs and window sills and door frames. Indicated for finishing board edges on joinery work used in coverings with direct finishes.





SAINT-GOBAIN

Gypsum Activity

Les Miroirs - 18, avenue d'Alsace
92096 la Défense Cedex
France
www.saint-gobain.com